

PL- Przed rozpoczęciem zapoznać się z instrukcją montażu/ DE- Vor die montage, bitte beiliegende anweisungen folgen/
EN- Before starting, refer to the assembling advice in annex/ CZ- Před zahájením naleznete v montážním návodu/ HR- Prije početka, uzmite upute za montažu u prilogu/
HU- A termék összeszerelését megelőzően kérjük olvassa el az összeszerelési útmutatóban leírtakat/ SK- Pred začiatkom si prečítajte pokyny na montáž

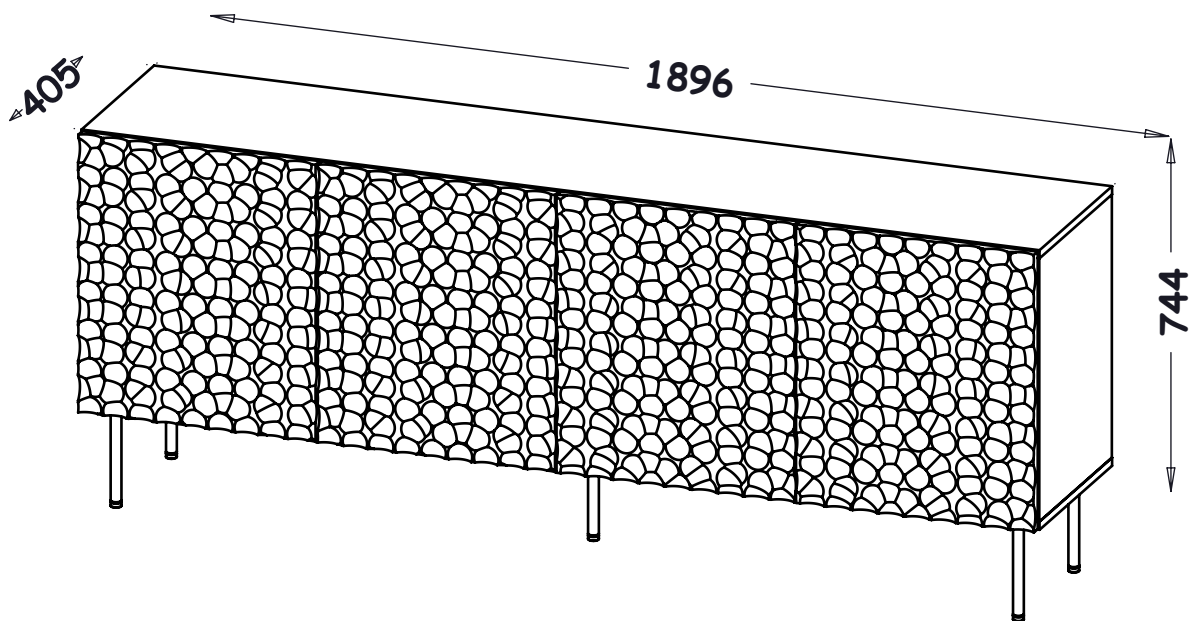

HOLE

Komoda 190



PL- Narzędzia niezbędne do montażu (nie dostarczone przez producenta)/ DE- Für die Montage notwendige Werkzeuge (nicht vom Hersteller mitgeliefert)/ EN- Tools required for assembly (not provided by the manufacturer)/ CZ- Nástroje nezbytné pro montáž (nejsou dodávány výrobcem)/ HR- Alat potreban za montažu (nije osiguran od strane proizvođača)/ HU- Az összeszereléshez szükséges (a gyártó által nem szállított) szerszámok/ SK- Nástroje potrebné na montáž (nedodávané výrobcom)

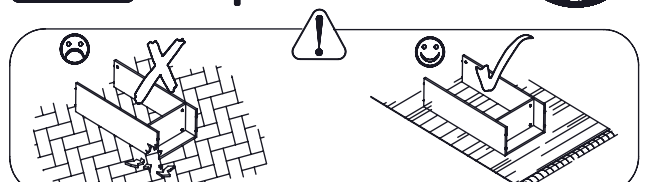
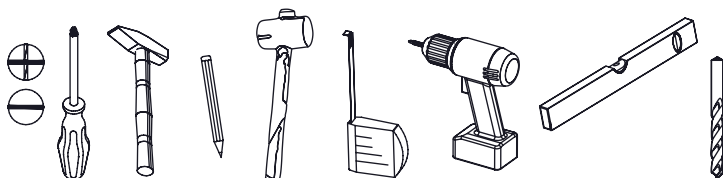



PL - UWAGA!

W przypadku reklamacji prosimy o podanie numeru serii znajdującego się na kartonie. W związku z tym prosimy o zachowanie opakowań do momentu zmontowania mebla. W przypadku stwierdzenia uszkodzenia któregoś z elementów, prosimy nie montować modułu, którego częścią jest dany element.

DE - HINWEIS!

Im Falle einer Reklamation geben Sie bitte die Seriennummer, die sich auf der Verpackung befindet. Daher bitten wir Sie immer die Verpackung solange aufzubewahren, bis die Möbelstücke vollständig montiert sind. Sollten Schäden an Einzelteilen auftreten, bitte sehen Sie von der Montage des Moduls ab.

EN - ATTENTION!

In case of claim please give us series number which you can find on the box. Thereupon please keep the package until montage of furniture is done. In case verified damage any of elements, please do not mount module, which is a parts of particular element.

CZ - POZOR!

Při reklamaci prosíme o uvedení čísla šarže, které se nachází na obale. V souvislosti s tímto prosíme o uchování obalů do okamžiku složení nábytku. V případě poškození některého z dílů, prosíme neskládat model, jehož součástí poškozený díl je.

HR - PAŽNJA!

U slučaju reklamacije, molimo Vas da nam date serijski broj koji možete pronaći na ambalaži. Molimo Vas da zadržite ambalažu sve dok nije kompletna montaža proizvoda. Ukoliko je uočeno oštećenje bilo kojeg elementa, molim Vas da ne montirate oštećeni dio.

HU - FIGYELEM!









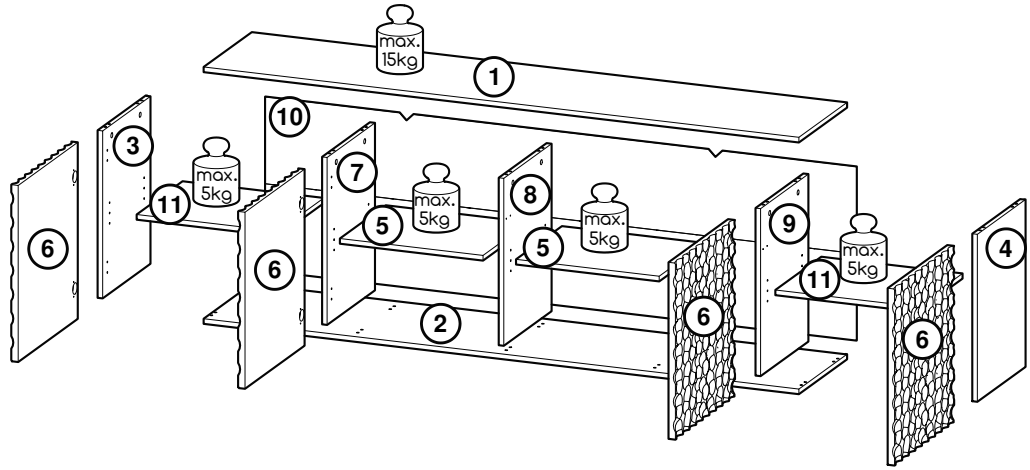

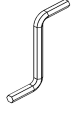

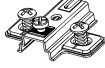







A bútor összeszereléséig kérjük őrizze meg a csomagolást, mivel reklamáció esetén a kartonon található szériaszámot kell megadni. Amennyiben észreveszi, hogy valamelyik bútorelem sérült kérjük ne folytassa az összeszerelését a modulnak melynek része az adott elem.

SK - POZOR!

V prípade sťažnosti uveďte číslo šarže na balení. Balenie preto uschovajte, kým nezostavíte nábytok. V prípade poškodenia niektorého z komponentov, nemontujte modul, ktorého je prvok súčasťou.

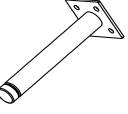
Nr	Xmm	Ymm	Zmm	x
1	1896	380	16	1
2	1896	380	16	1
3	517	380	16	1
4	517	380	16	1
5	456	362	16	2
6	470	545	22	4
7	517	377	16	1
8	517	377	16	1
9	517	377	16	1
10	1884	537	2,5	1
11	450	362	16	2

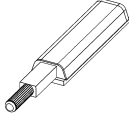

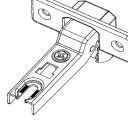
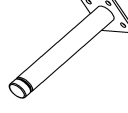
W4 72x 	W2 1x 4mm 	F2 16x ø5 	D3 4x PZ35PR 	G5 16x 4x13 	C3 4x Z35PR 
J24 2x L150 	G37 2x ø4x13 	S26 4x ø6/16 	G17 2x 4x45 	U6 2x ø8x40 	A1 10x ø7x50 
K1 10x ø15x12 	K5 10x 34mm 	I20 10x ø4/ø17 	B1 20x ø8x35 	G34 8x 3,5x16 	P65 4x H200 
G4 20x 4x16 	L21 4x 	D15 4x PZ35BLI 	C15 4x Z35BLI 	P66 1x H200 	

I

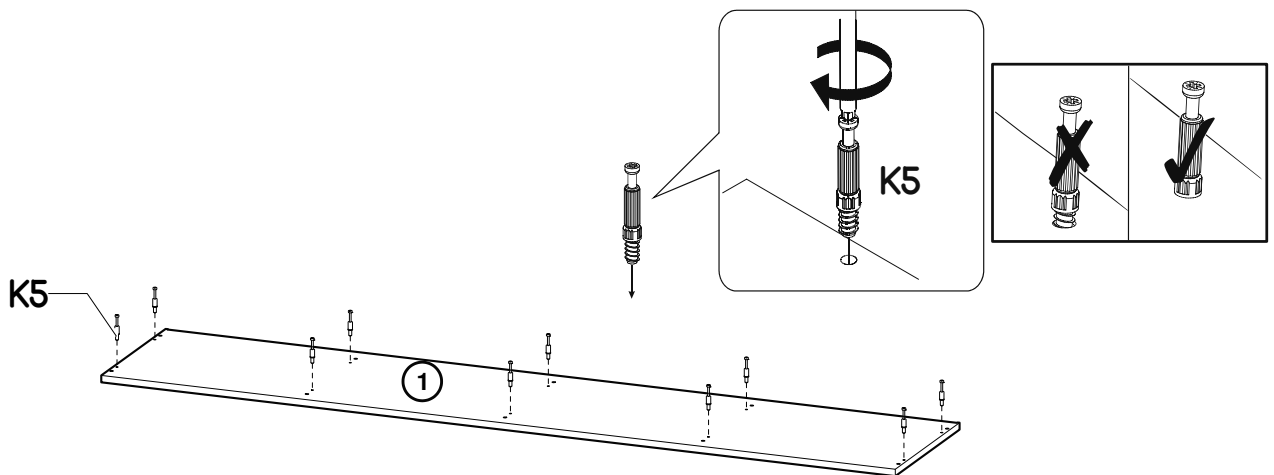

II

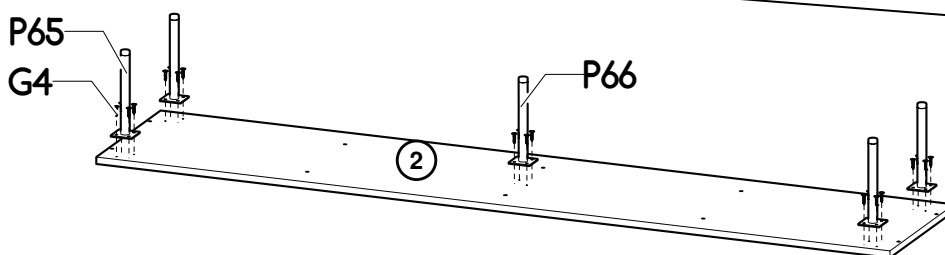

III

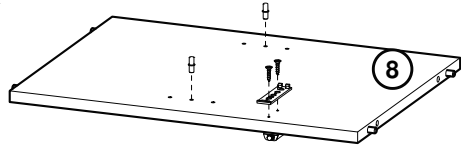
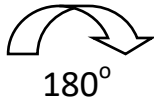
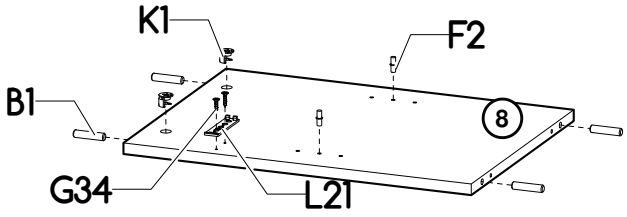
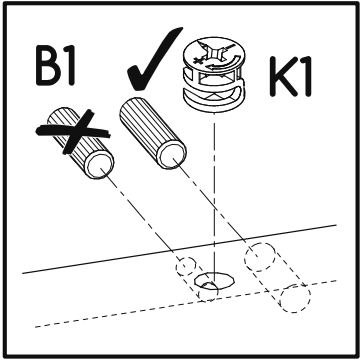
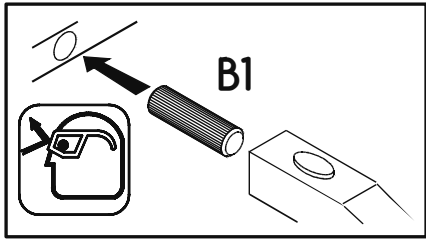
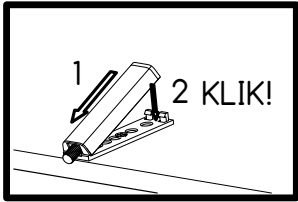

IV

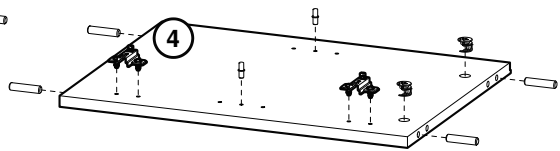
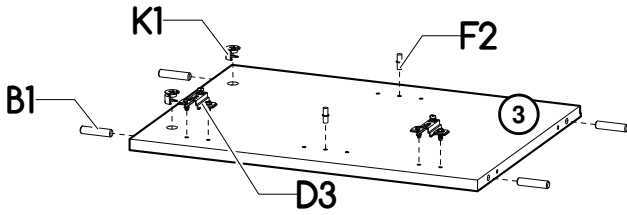
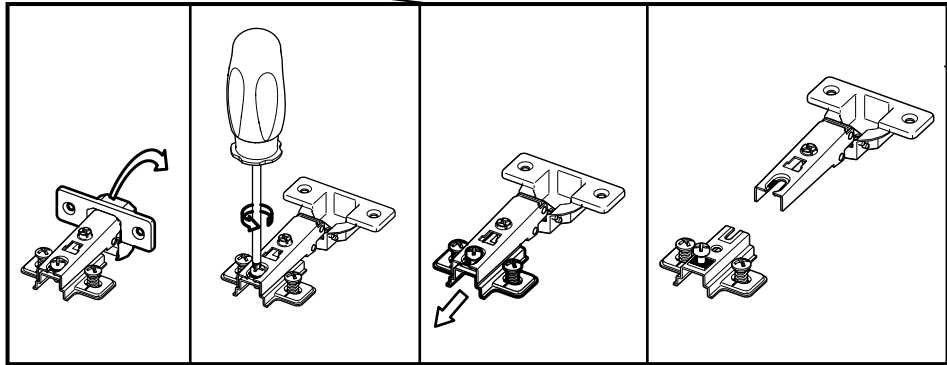
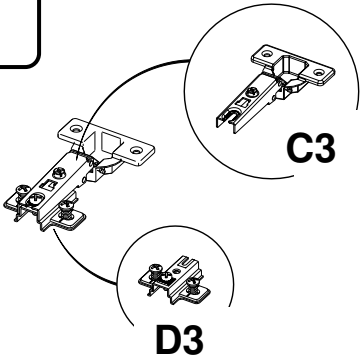

V

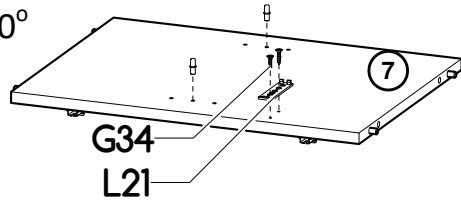
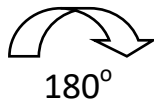
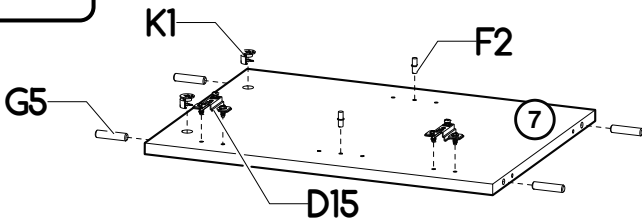

VI

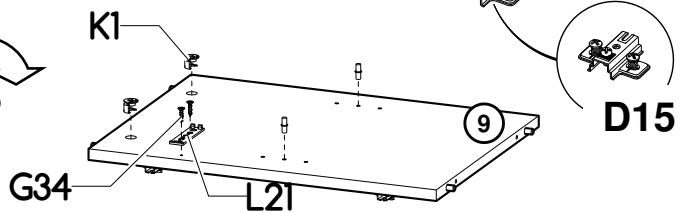
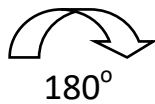
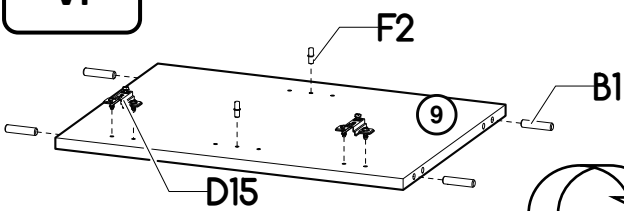

VII

x2

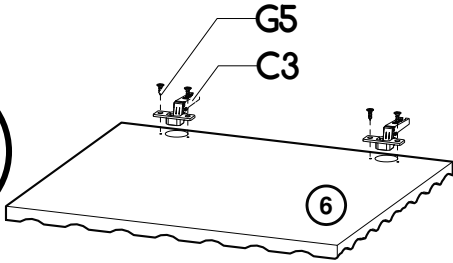

x2

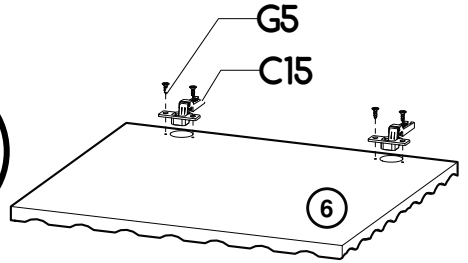

VIII

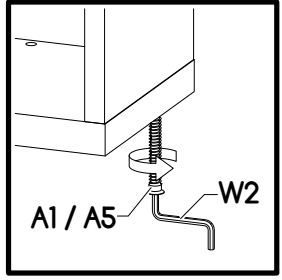
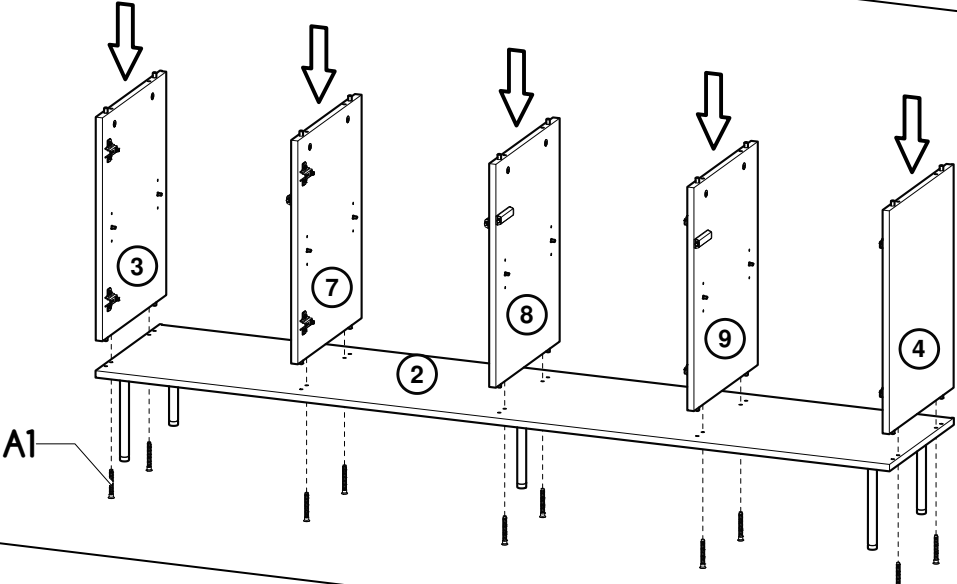

IX

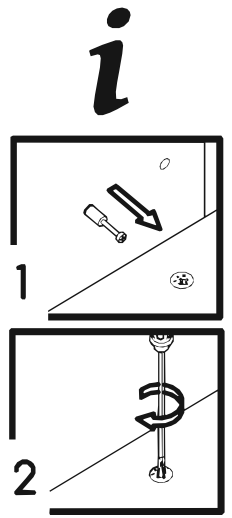
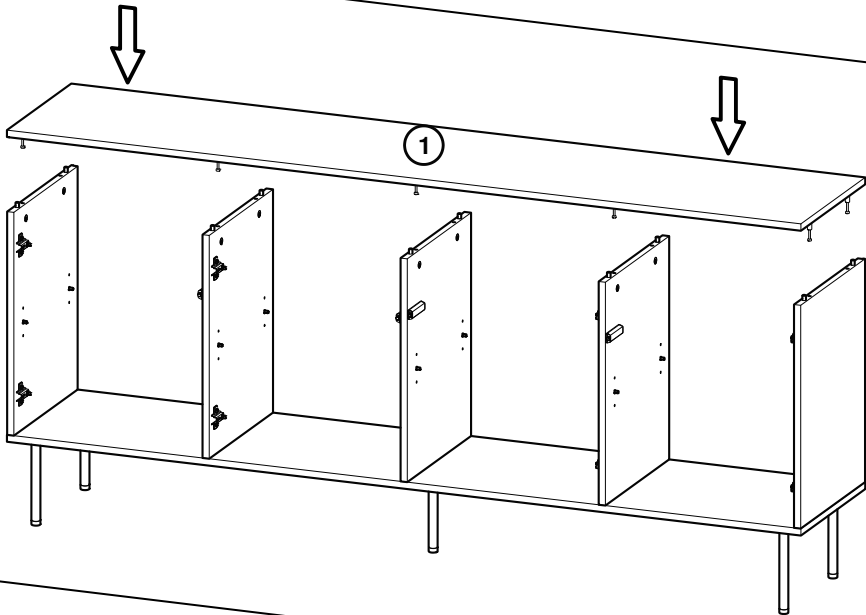

X

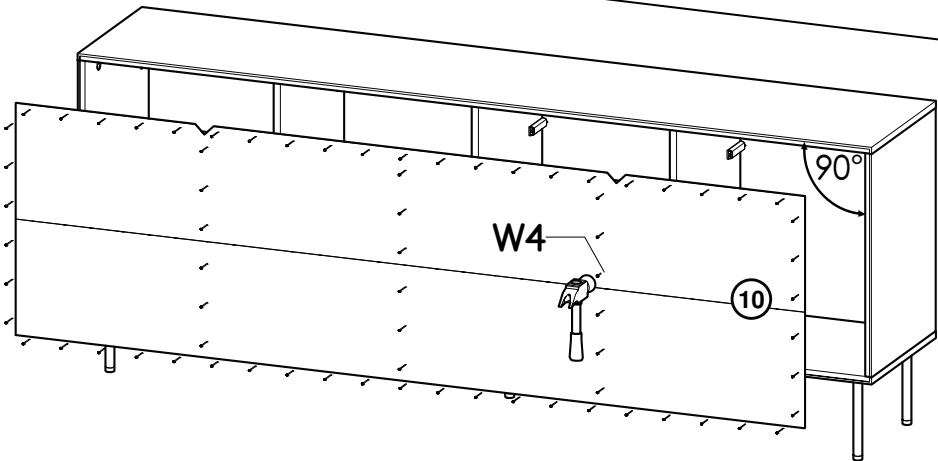

XI

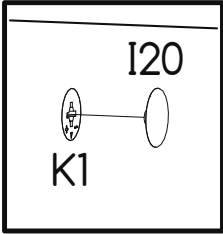
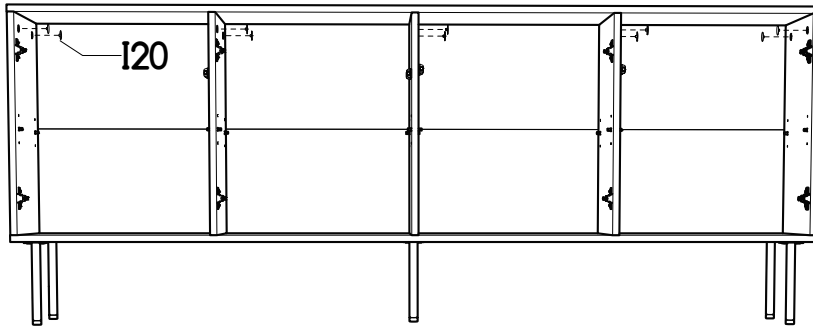

XII

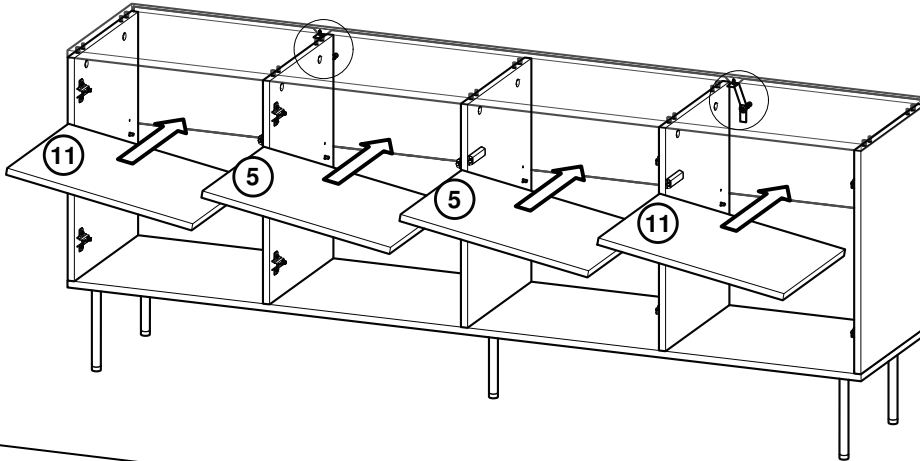
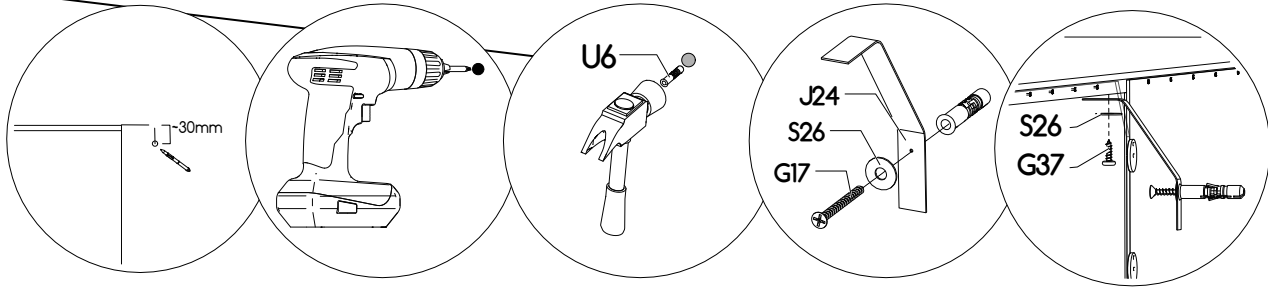

XIII

